



愛知用水

Outline of the Aichi Irrigation Project

Start of the Aichi Irrigation Project

Aichi Irrigation Project



Local Situation

- ◆ Aichi Prefecture's Chita Peninsula lacks water
- ◆ Major successive droughts in 1944 and 1947
- ◆ Strong local movements for irrigation canals

National Policy

- ◆ Acute postwar food shortages
- ◆ Trend for emphasis on land development

Aichi Prefecture's Chita Peninsula Lacks Water

- No large rivers
- Ensuring agricultural water with storage reservoirs
- Ensuring domestic water with beach wells



Scooping up groundwater



Housewives carrying water from beach wells

Strong Local Movements for Irrigation Canals



A passionate explanation meeting to bring about irrigation canals in Aichi

History of Aichi Irrigation

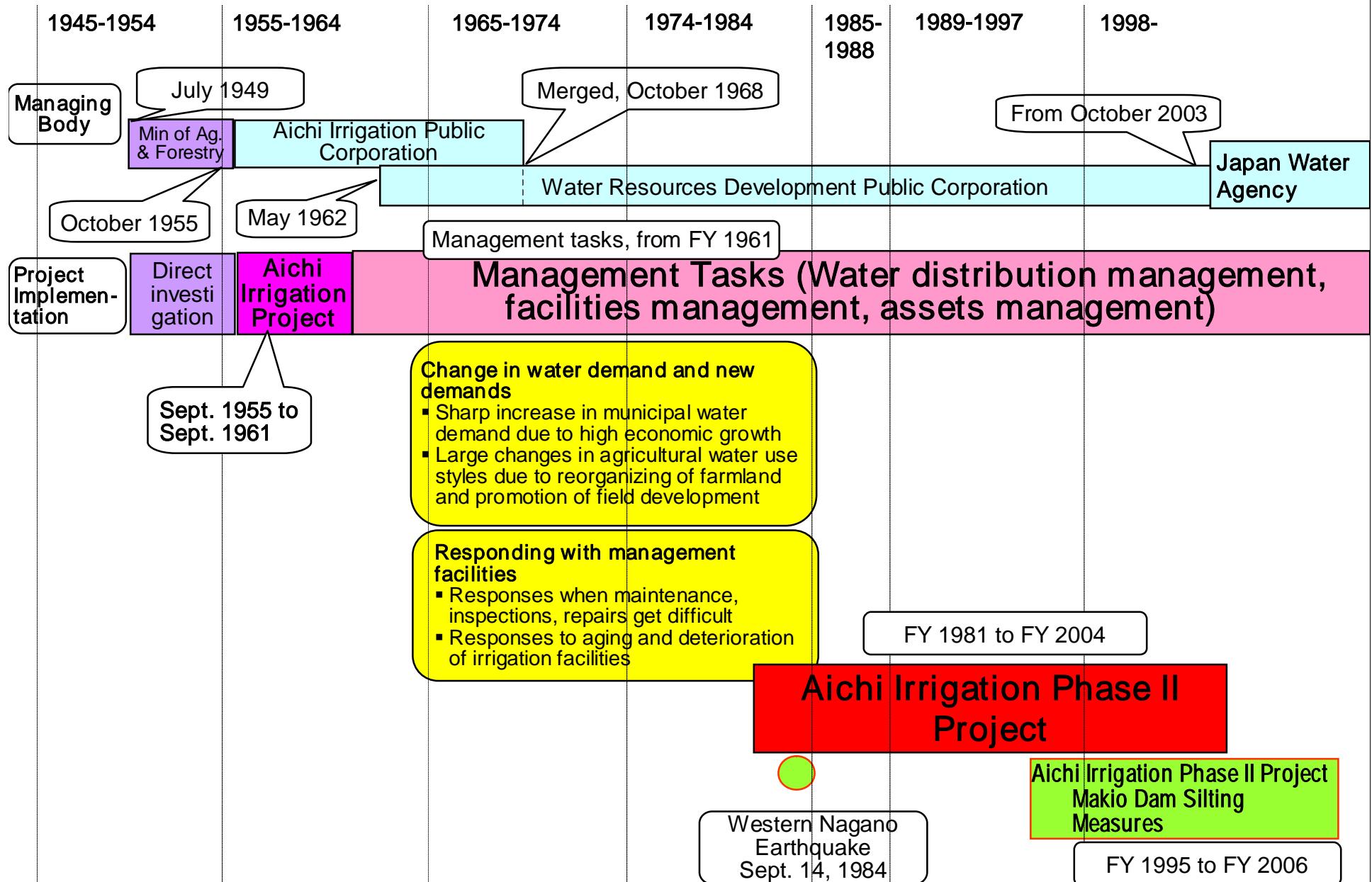

Outline of Aichi Irrigation Project

(Phase I)

Makio Dam

Kiso River

Kaneyama Intake

Aichi Pond

Main Canal

Miyoshi Pond

- ◆ First large scale general development projects in Japan (agricultural water, water supply water, industrial water, power generation) centering on agricultural development
- ◆ Water source facilities (Makio Dam), Main canal (length, 112 km), Lateral canal (length, 1,012 km), and others, for unified implementation
- ◆ Water supplied to: Kani County, Gifu Prefecture; Owari Eastern Hills, Aichi Prefecture; Chita Peninsula area
- ◆ Built between 1955 and 1961
- ◆ Implemented with formation of Aichi Irrigation Public Corporation

Characteristics of Phase I Project

- ❶ Brought in foreign capital (World Bank loans)
- ❷ Establishment of Aichi Irrigation Public Corporation
- ❸ Active cooperation of related organizations
- ❹ Unified implementation (from dams to terminal waterways, canals, and power generation facilities)
- ❺ Technical cooperation from U.S. consultants
- ❻ Totally mechanized implementation
- Ⓞ Project completed in the short time of five years



- ★ Results rapidly apparent
- ★ Later major contributions to civil engineering techniques



Oct.	1955	Aichi Irrigation Public Corporation established
Aug.	1957	World Bank loan contracts and government guarantee contracts signed
Nov.	1957	Work starts
Sept.	1961	Construction work completed/Water starts flowing

Construction Work (Makio Dam)

Night rush work



December 1, 1958: Main body begins construction

May 28, 1961: Makio Dam completed

Construction Work (Open canals)

Casting thin lining concrete



Outline of the Aichi Irrigation Phase II Project



Waterway Areas Being More And More Developed



Kasugai City Kozoji New Town

Kozoji

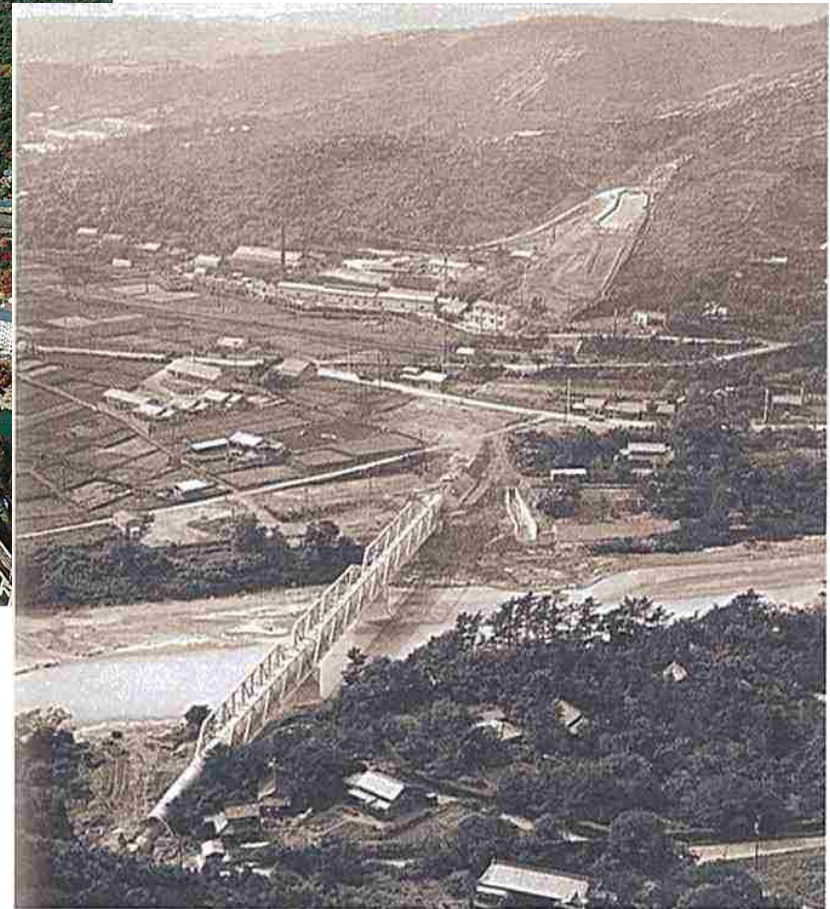

Sharp Increase in Municipal Water Demands due to High Economic Growth

Cannot cut off water

Intake pattern (plan)

1963

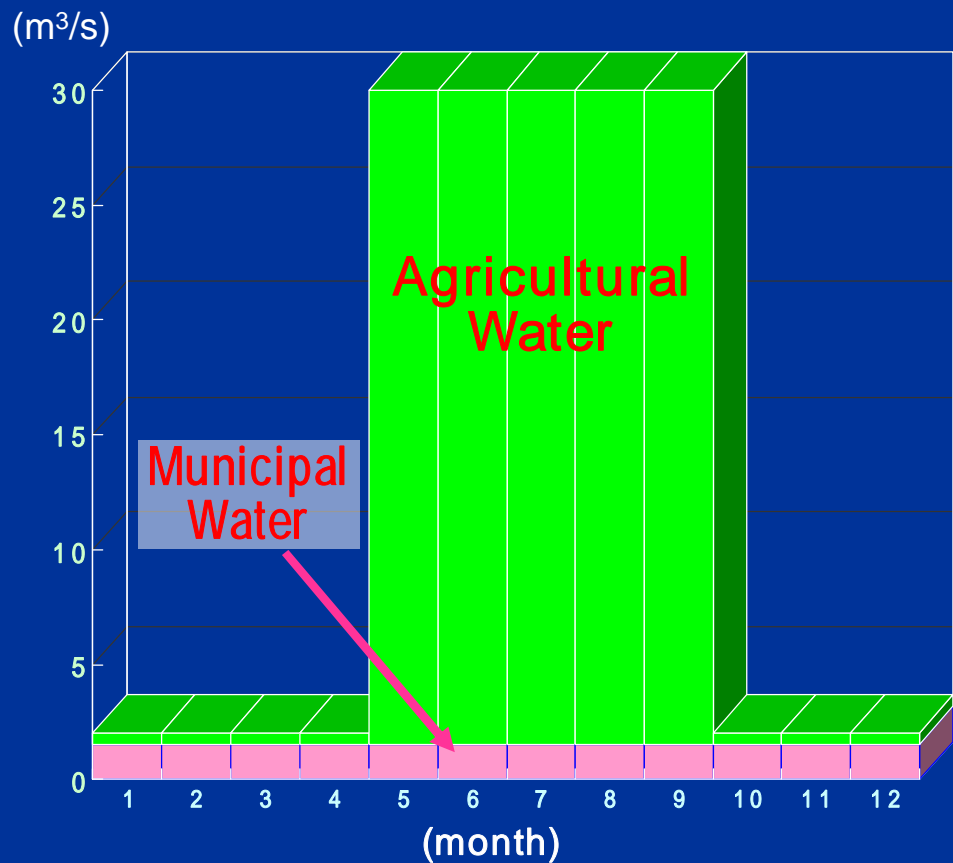

1981

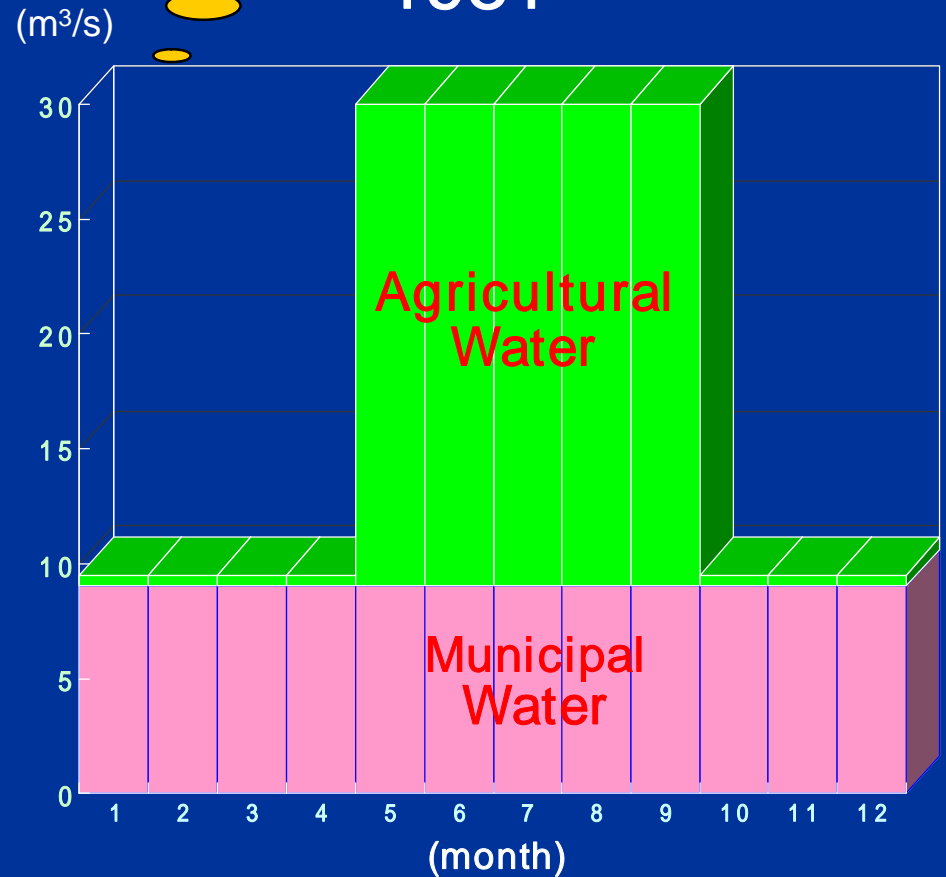

Loss of Durability and Carrying Capability through Aging

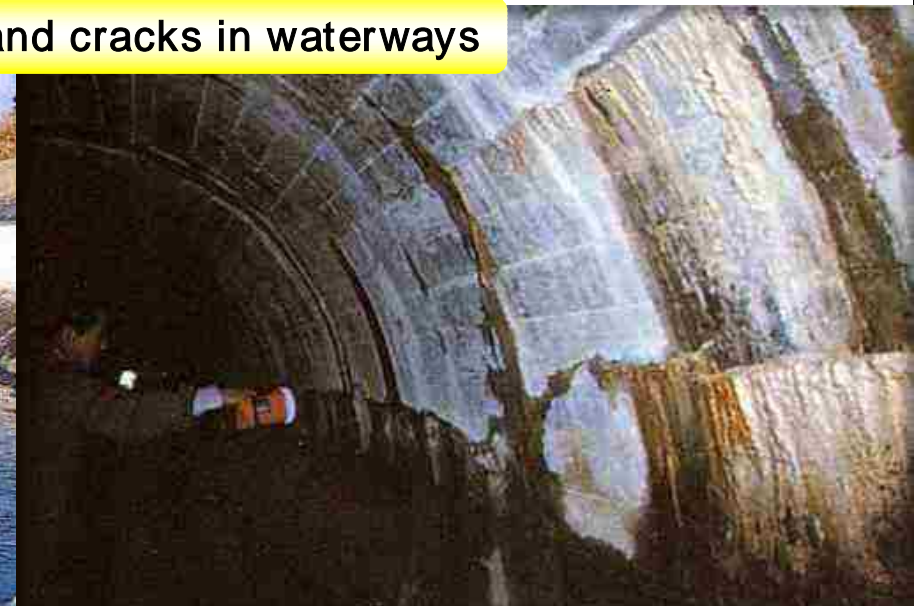

Development into Phase II

Changes in water demand and new demands

- Sharp increase in municipal water demands due to high economic growth
- Large changes in agricultural water use styles due to reorganizing of farmland and promotion of field development

A wealth of management facilities

- Responses to aging and deterioration of irrigation facilities
- Responses when maintenance, inspections, repairs get difficult

Work Plan for Phase II

Reconstruction of Main Canal Facilities, etc. (FY 1981–FY 2004)

- Doubling of main canals
- Increase of flow capacity
- Modernization of water management facilities
- New terminal balancing reservoir
- Making lateral canals into pipelines

Makio Dam Silting Measures (FY 1995–FY 2006)

- Silt removal (approx. 5,480,000 m³)

Doubling of Main Canals (Waterway schematic plan)

Main Canal Schematic Plan

Phase I

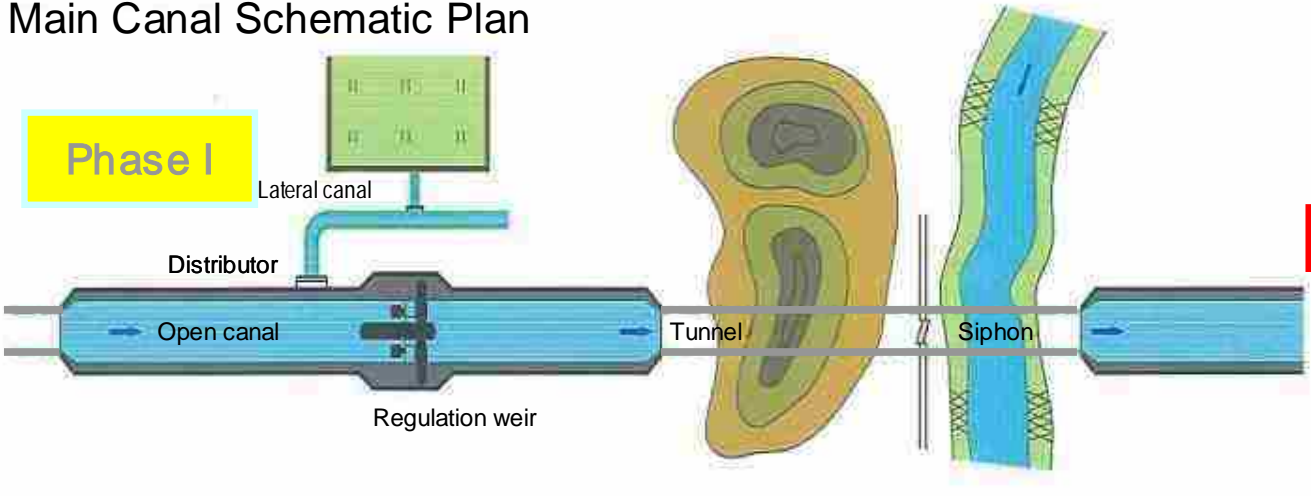

The diagram for Phase I shows a main canal starting as an open canal on the left, passing through a regulation weir, then a distributor, and a lateral canal. It then transitions into a tunnel, followed by a siphon, and ends as an open canal on the right. A topographic map and a cross-section of the siphon are also shown.

Labels: Lateral canal, Distributor, Open canal, Regulation weir, Tunnel, Siphon.

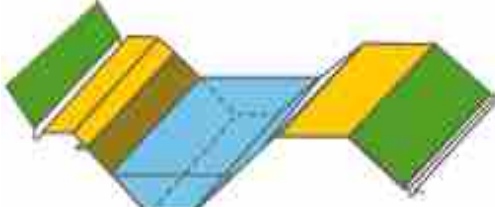

A 3D perspective view of a thin concrete lining structure, showing a blue channel between two concrete walls.

Thin concrete lining in waterway



A photograph showing a narrow waterway with thin concrete lining on the banks, situated in a rural area.

Phase II

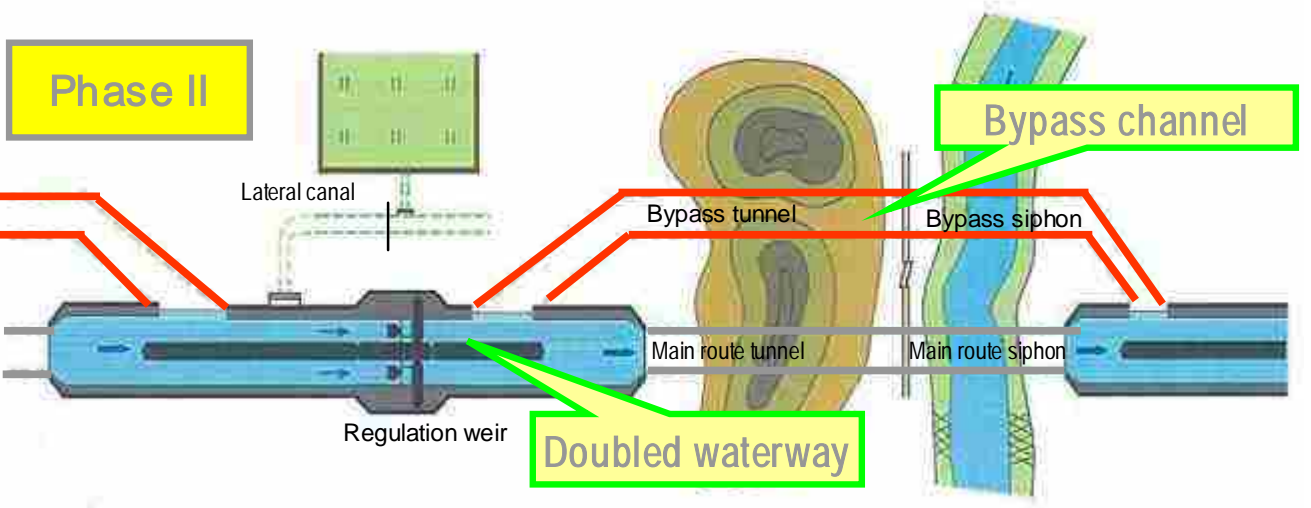

The diagram for Phase II shows the main canal from Phase I being doubled. A new bypass channel is added, consisting of a bypass tunnel and a bypass siphon. The original main route tunnel and siphon are labeled as the main route. A green box highlights the 'Doubled waterway' area. A 3D perspective view of the doubled flume waterway is also shown.

Labels: Lateral canal, Regulation weir, Bypass tunnel, Bypass siphon, Main route tunnel, Main route siphon, **Doubled waterway**, **Bypass channel**.

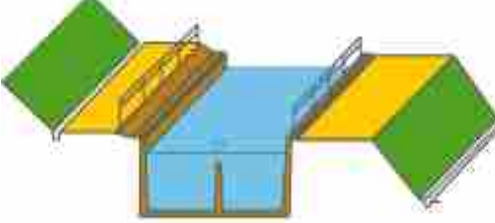

A 3D perspective view of a doubled flume waterway, showing two parallel concrete-lined channels.

Doubled flume waterway



A photograph showing a wide waterway with two parallel concrete-lined channels, illustrating the doubled flume waterway.

Doubling of Main Canals (Standard cross-section)

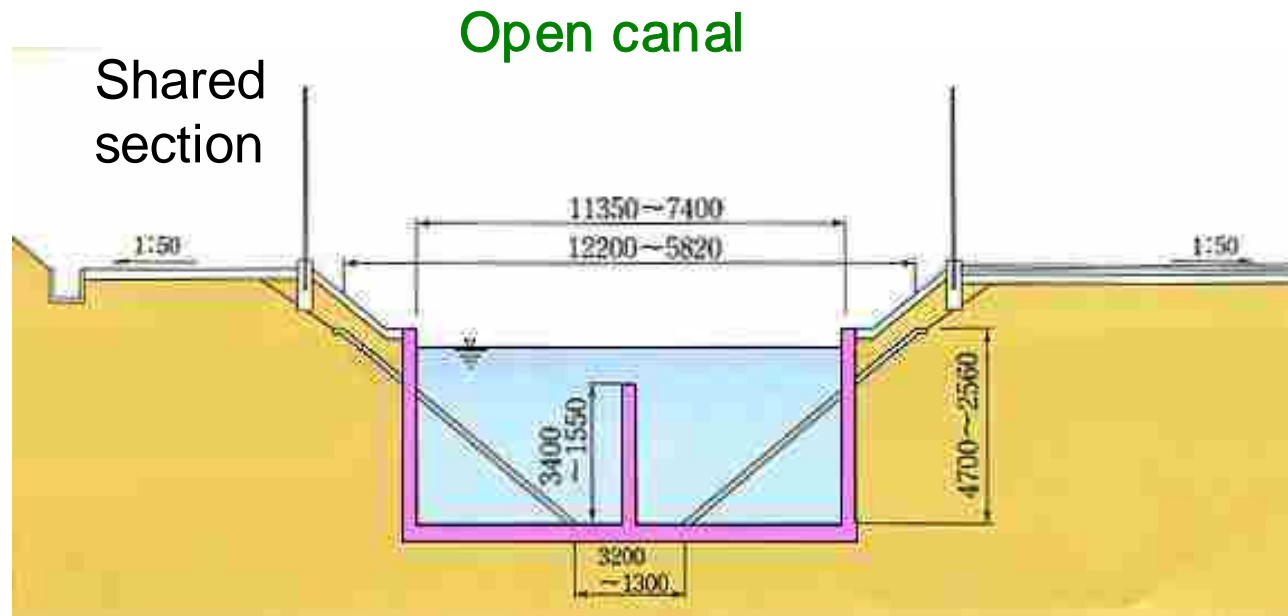

Agricultural water only section

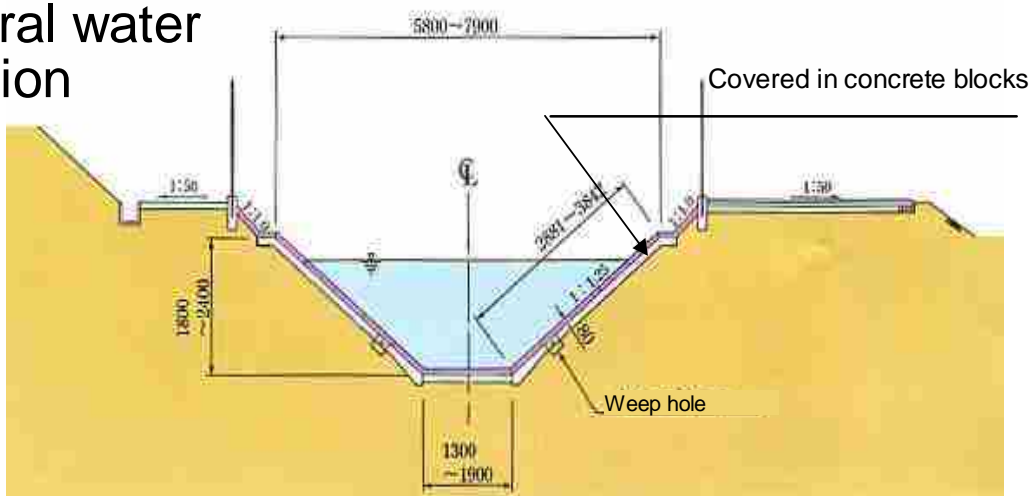

Tunnel

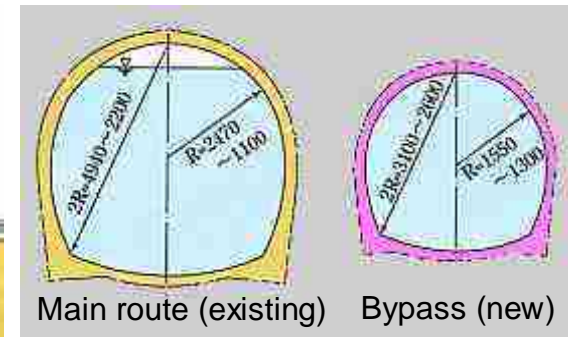

Full flow in
bypass tunnel

Siphon

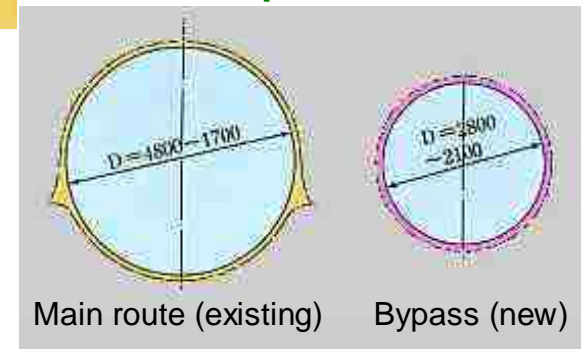

Modernization of Water Management Facilities

Migration to centralized facilities method

- From management relying on human interaction to introduction of remote monitoring/control and centralized management
- Reduction of time and labor needed for water management
- Early detection of abnormalities and early determination of abnormal locations

Placing of water management devices

- Remote monitoring and control
(main intakes, outlet, etc.)
- Remote monitoring
(trunk flow volume, trunk water levels, check gate open angles, diverted water amount, device status, etc.)

Management systems and division of labor

- Distributed water management
From distributed management to centralized management
- Facilities management
From four distributed management offices to three
(main canals)

Modernization of Water Management Facilities



Remote Monitoring and Control of Principle Facilities

Main intakes, outlet, etc.

Main facilities deemed necessary to respond immediately to water source status, water demand, weather conditions, and other changes where frequent flow regulation operation is required

Facilities where emergency operation is required

- Kaneyama Intake Gate
- Togo Balancing Reservoirs M, B Outlet
- Sakuragane CH Gate, Sori Pond Distributor

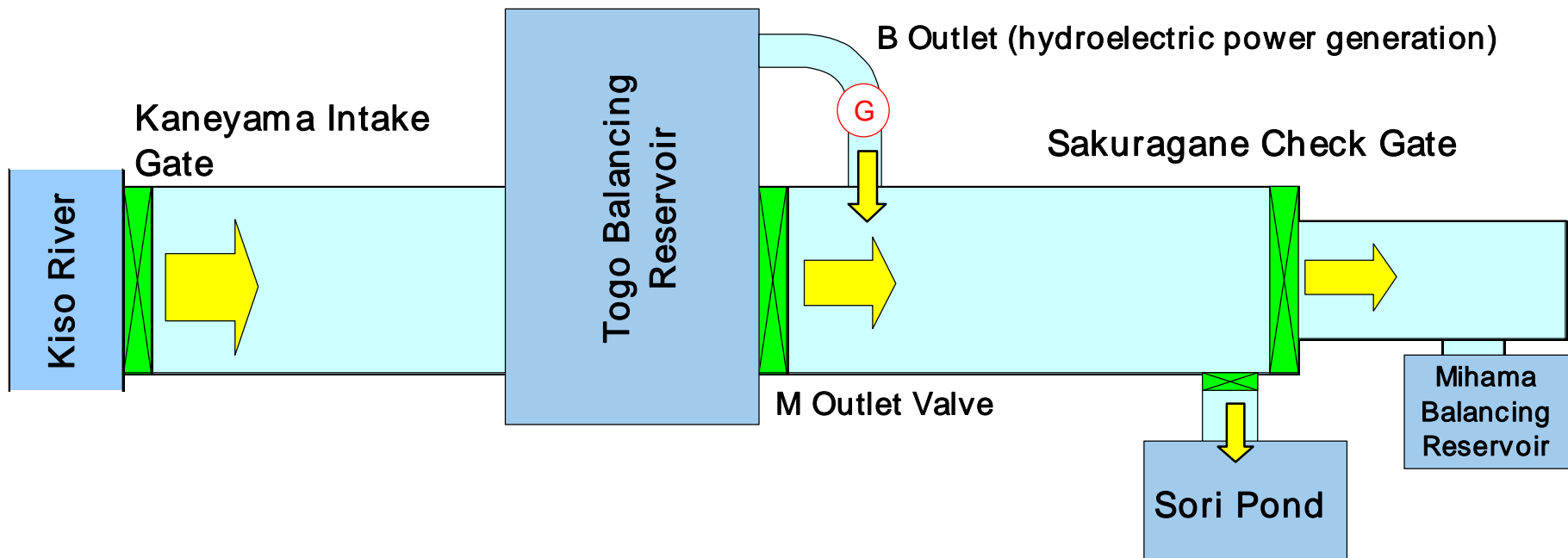

Remote Monitoring of Trunk Flow Volumes

- Early detection of abnormalities and early determination of abnormal locations
- Check of water arrival when flow volume changes or large volumes are introduced
- Highly accurate water distribution implementation (effective use of water resources)
- Supplementation for flow volume change or device change periods

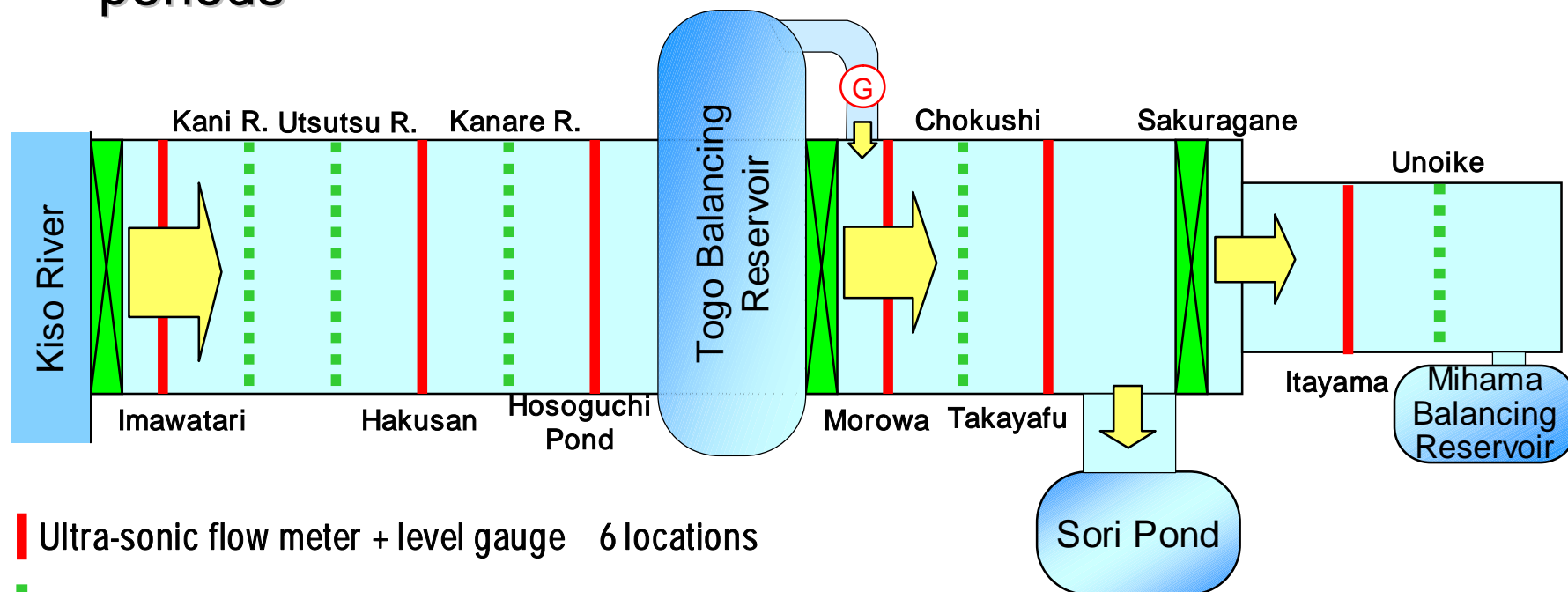

■ Ultra-sonic flow meter + level gauge 6 locations

■ CH gate opening indicator + level gauge 6 locations * Incl. Sakuragane CH

Remote Monitoring of Trunk Water Levels

- Ensuring appropriate trunk water levels
- Checking water arrival when flow amount changes or floods are introduced (CH lower reaches)
- Early detection of abnormalities and early determination of abnormal locations (locations that need watching)
- Grasping storage volume in main canals (agricultural water use only sections)

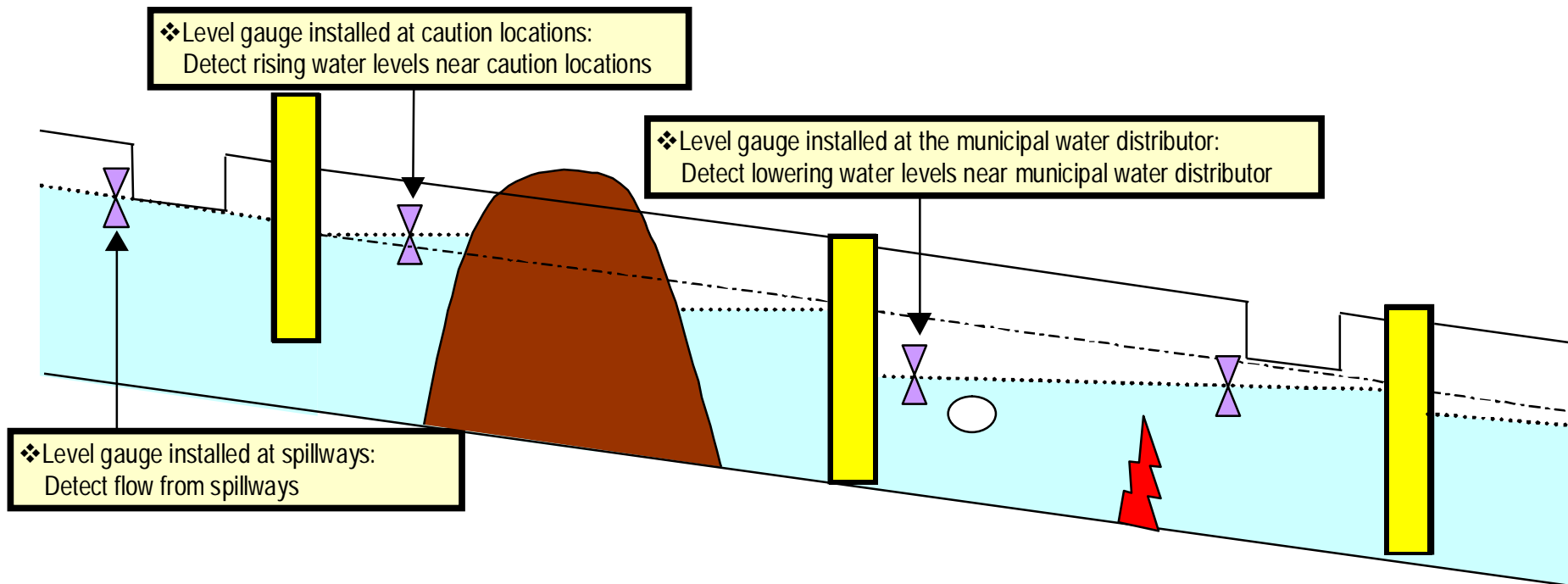

Water Level Adjustment Gates (Check Gates) Non-Motive Automation

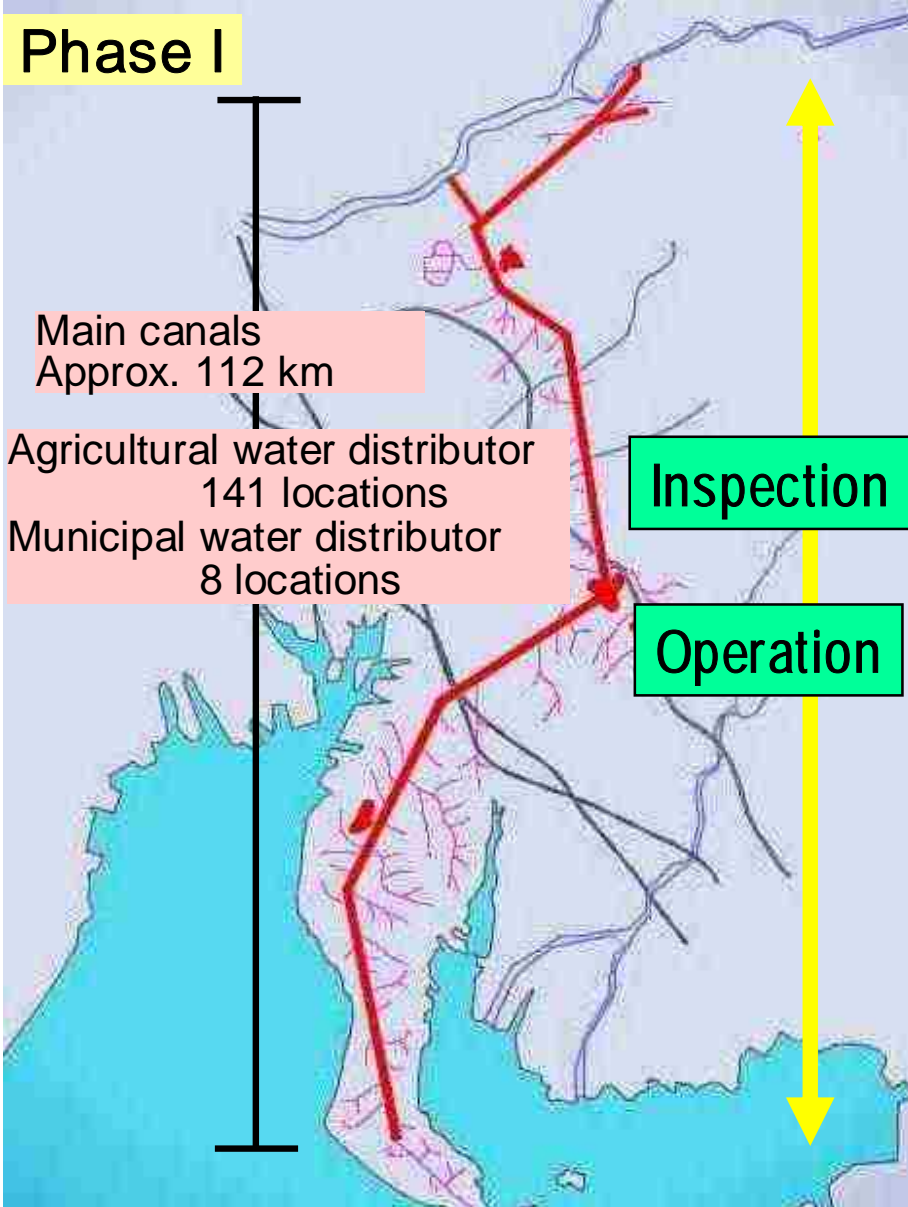

Phase I

Maintenance of appropriate trunk water levels and distributor water levels during trunk flow volume change

Of 37 total trunk gates, 18 electric gates are mechanically operated

Water management to ensure parallel flow with pilot



Electric radial gate

Phase II



14 trunk CH gate locations changed to non-motive automation

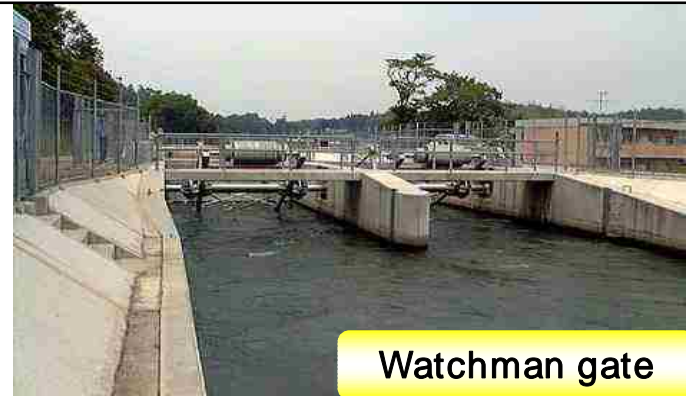

Watchman gate

New Terminal Balancing Reservoir (Mihama Balancing Reservoir)



1. Goals of construction

Along with storing and using the unused water that flows down to the terminus of the Aichi irrigation main canal, it is intended to provide a stable supply of agricultural water downstream from the balancing reservoir during periods when the arrival water volume is low. It is also designed to increase the degree of freedom in water management by making the trunk water flow hold its width by using the empty storage capacity of the balancing reservoir.

2. Balancing reservoir stats

Stored water volume: Approx. 100,000 m³ (surface area when filled: approx. 2.3 ha)
Effective water depth: 5 m

Storage of unused water

Responses to lack of arrived water volume

Effective use of water resources

Stable supply

Making Lateral Canals into Pipelines

Phase I (Open-type waterways) Supply initiated waterway

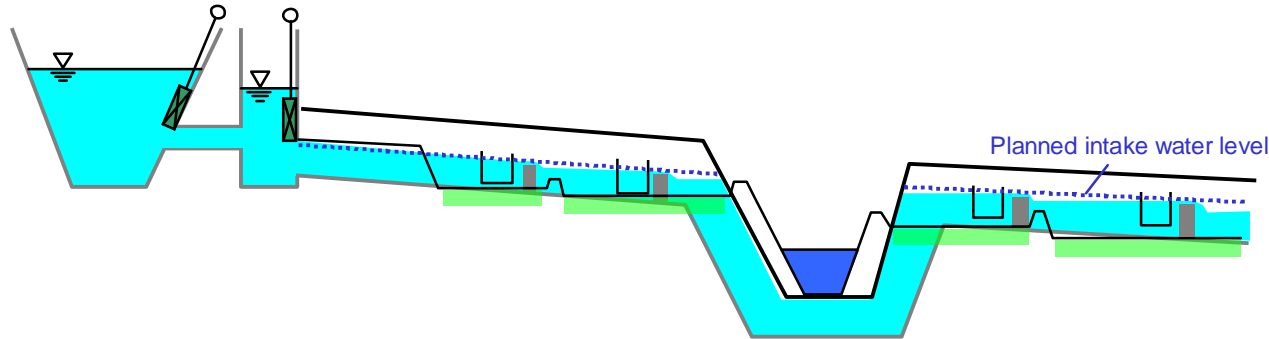

Upstream
priority

Assurance of conveyance, improvement of durability
Shortens time for water arrival to fields
Reduces time and labor related to water management and facilities management
Provides a stable supply to fields
Effective use of water resources through reducing unused water, non-arriving water volume, and management water
Reduction of time and labor relating to trunk distributor operation

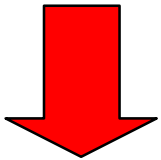

Phase II (Pipe-type waterways) Demand initiated waterway

E.g.) Water supply taps

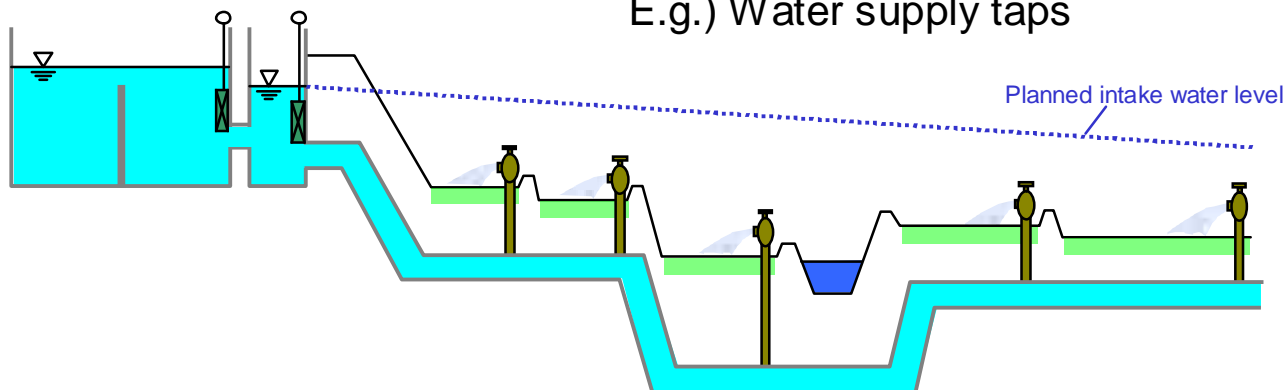

Lower areas
priority

Makio Dam Silting Measures

The massive amount of silt that flowed into the dam lake as a result of the Western Nagano Earthquake (Sept. 1984) was removed, and the reservoir functions restored.



New Responses with Phase II Project

Phase I Issues

Maintenance inspections in non-suspension water was difficult

Flow management and distribution management required time and labor

Early detection of flow status/distribution status and abnormalities was difficult

Response to agricultural water with its highly variable demands (in particular, the agricultural water only section downstream from the Sakuragane CH)

Occurrence of unused water at the trunk terminal and response to lack of arrival water amount

Water management of lateral canals

Phase II Responses

Doubling of main canals

Non-motive automation of water level regulation gates

Introduction of remote monitoring and control

Reinforced use of existing waterways (assurance of storage capacity)
Addition of downstream water level catchup functions to check gates and storage functions

New terminal balancing reservoir

Making lateral canals into pipelines

Main Effects of the Phase II Project

◆ Responses in Phase II

- Non-motive automation of water level regulating weirs
- Making lateral canals into pipelines
- Introduction of a remote monitoring and control system
- Increase of conveyance ability
- Doubling of main canals
- New terminal balancing reservoir

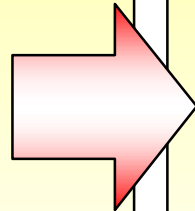

◇ Effects

- Work efficiency and reduction of labor through unified centralization of management allowed a reduction in the management staff
- Responding to changes in water demand, and contributing greatly to local development
- Made it possible for maintenance inspection by using single-sided flow
- Extending the life of facilities through preventive maintenance measures
- Non-effective outflow suppressed

Unified Centralized Management

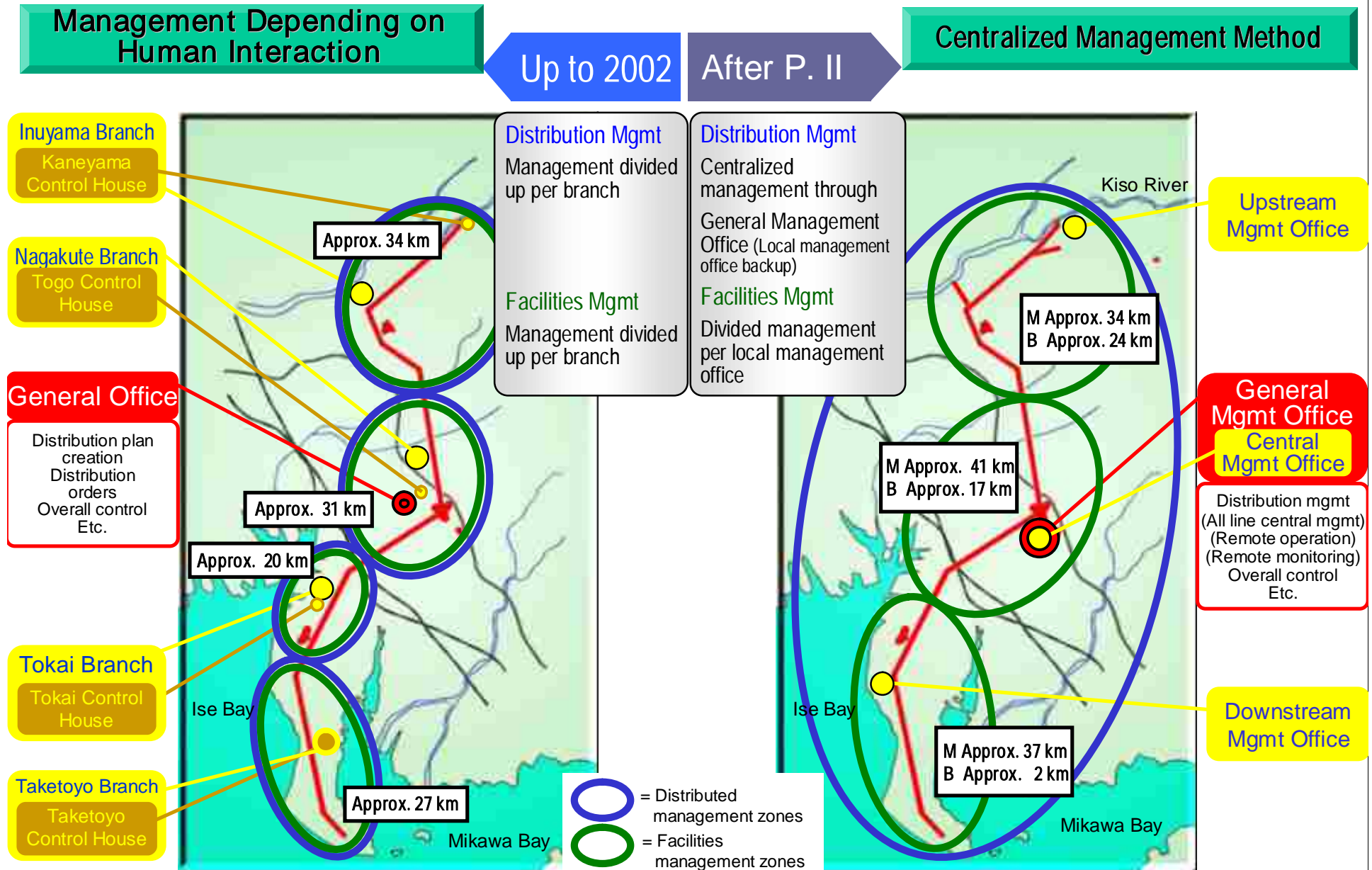

Changes of Water Use

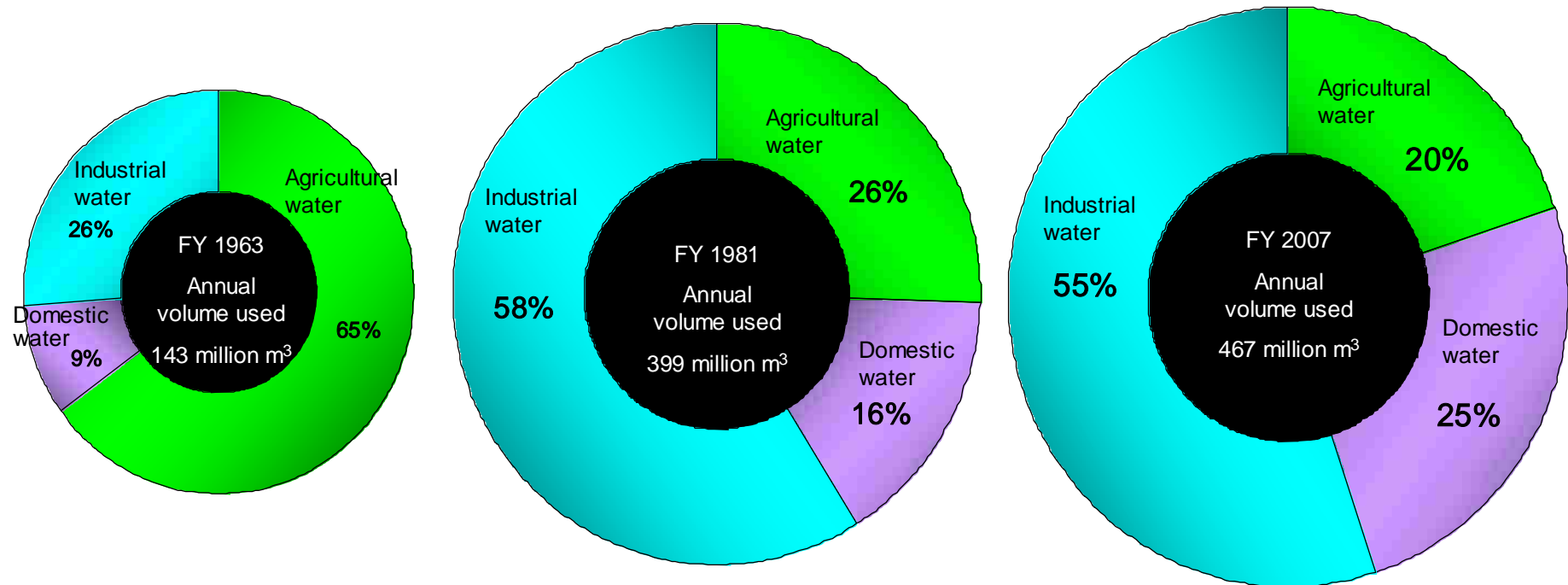

Annual volume used FY 2007: Approx. 470,000,000 m³
(Approx. 376 times the volume of the Nagoya Dome)

The volume is more than triple that of FY 1963

The weight has shifted from agricultural water to municipal water
(agricultural water 1/5; municipal water 4/5)

Effects of the Project

Agricultural water

Agricultural gross value
FY 2003: Approx. 67 billion yen

Domestic water

Population served by piped water
FY 2005: Approx. 1,130,000

Industrial water

Produced article shipment total
FY 2003: Approx. 3.4 trillion yen

Agricultural gross value (millions of yen)	
Division	Related municipalities
FY 1963 (A)	25,566
FY 2003 (B)	67,013
Ratio (B/A)	2.62

Population served by waterworks (thousands of people)	
Division	Population served by piped water
FY 1963 (A)	195
FY 2005 (B)	1,130
Ratio (B/A)	5.79

* Includes Gifu Pref. Tono area

Produced article shipment amount etc. total (hundred billions of yen)	
Division	Related municipalities
FY 1963 (A)	3,259
FY 2003 (B)	34,382
Ratio (B/A)	10.55

* 76 offices

Maintenance Inspections in Non-Suspension Water

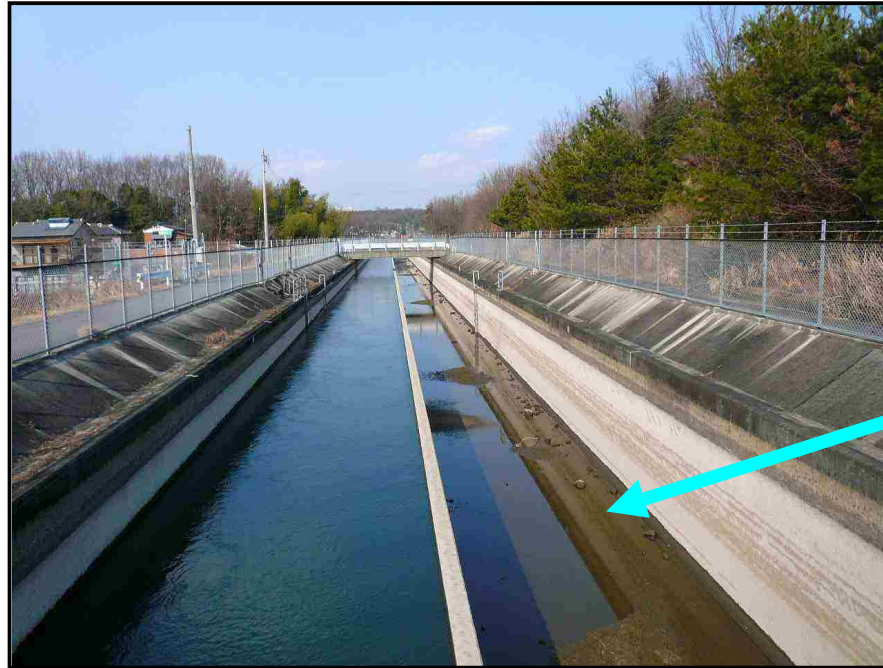

Empty water image

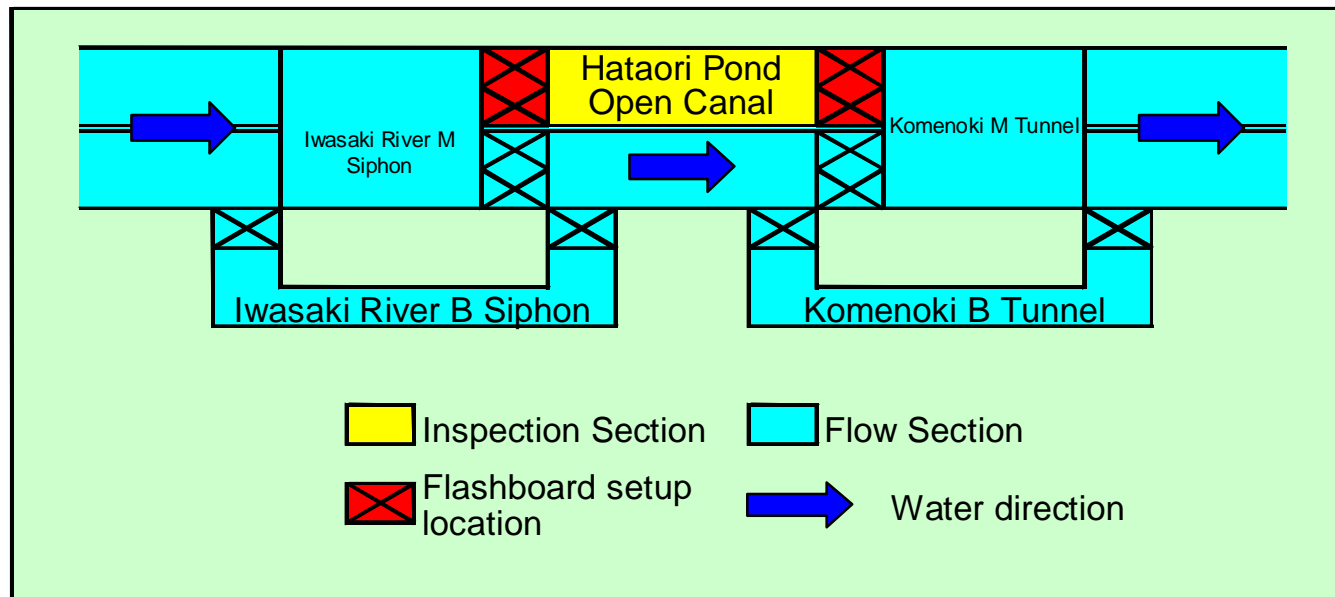

Maintenance Inspection

(1) Cleaning inside the waterways, removal of sediment from the waterways

Cleaning



Silted sediment



Removal of silt and sediment



(2) Inspection and maintenance work in the waterways

Inspection



Junker



Repairing



Maintenance Inspection and Repair Effects

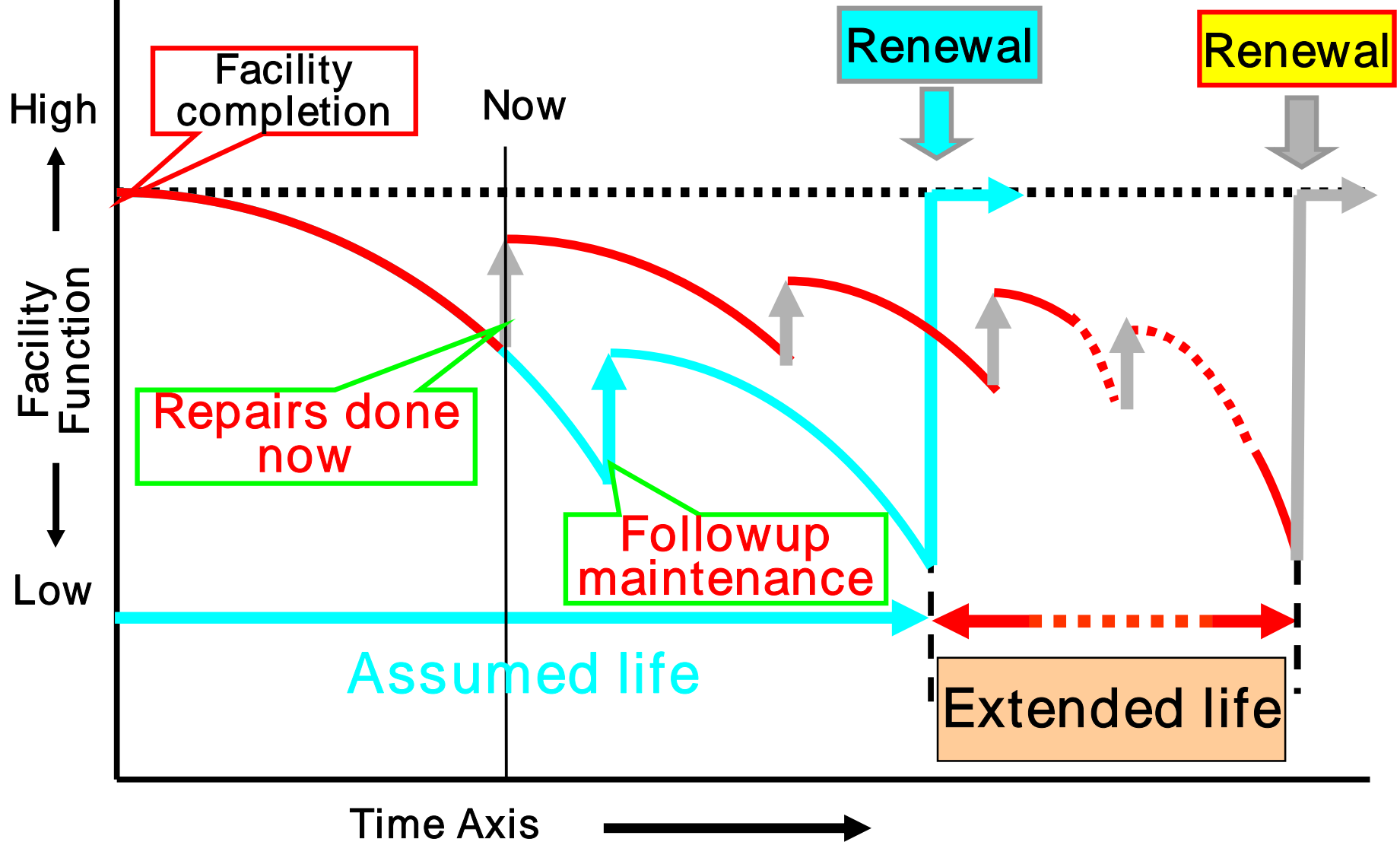

A New Try

Operation of the Togo Power Station

- Power generation using the drop (approx. 14.3m) between the Togo Balancing Reservoir and the Morowa No. 1 Open Canal
- First RPS recognized facility for a water organization
- Power generated contributes to the reduction of load for management costs

Togo Balancing Reservoir

M Outlet

Morowa No. 1
Open Canal

General Management Office

Togo Power Station (B Outlet)

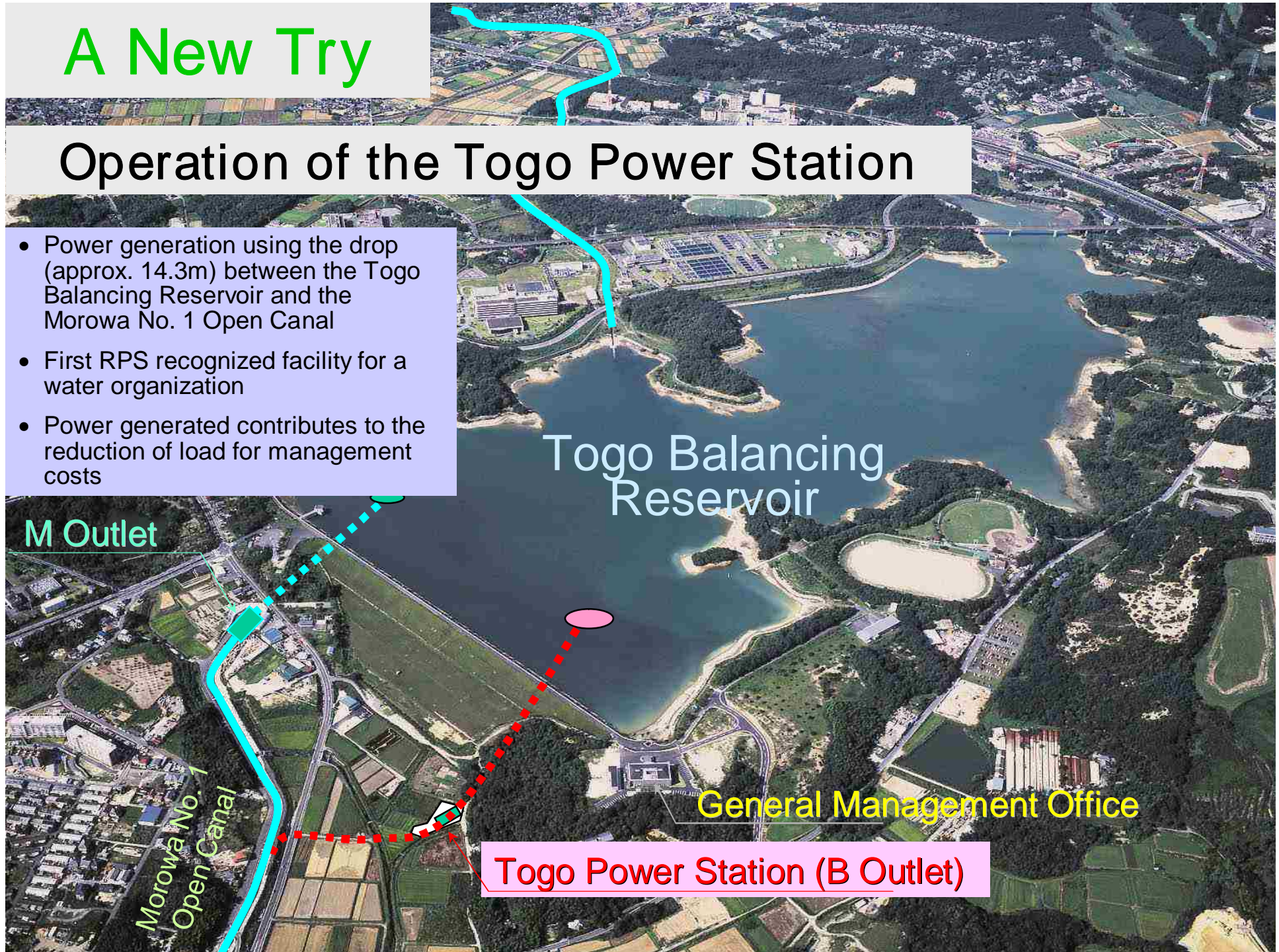

Large-Scale Solar Power Generation System in Aichi Pond

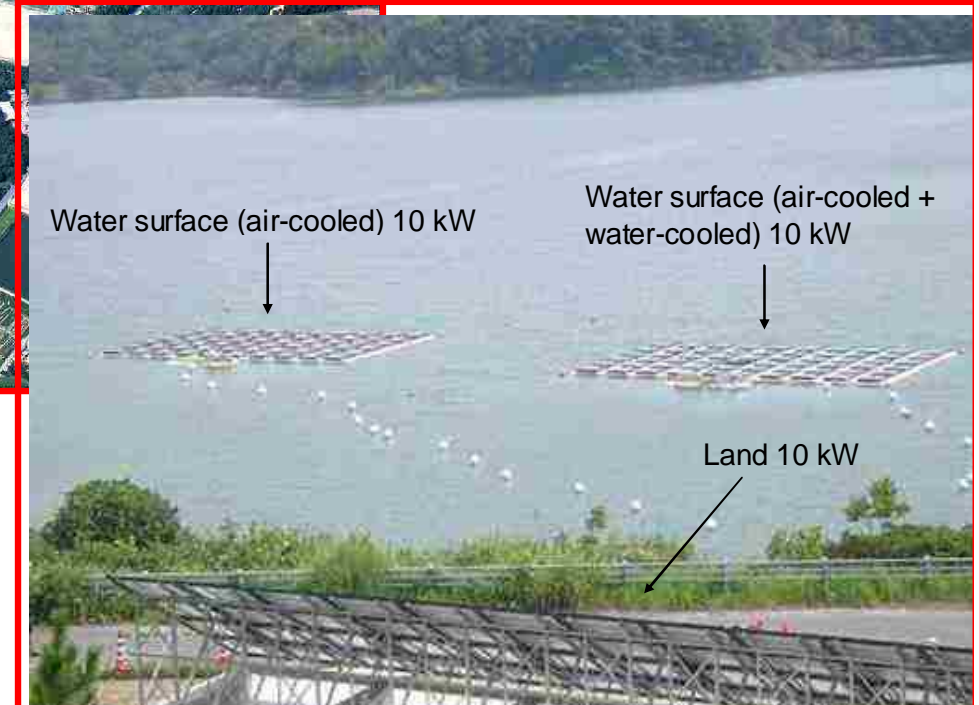

Aichi Pond Large-Scale Solar Power Generation System

Part of the "FY 2007 Global Warming Prevention Technology Development Program" (Ministry of the Environment)

● Goal of Technical Development

With the aim of putting the large-scale solar power generation system that uses the surface of water into practical use, the Japan Water Agency is carrying out the following technical developments:

- (1) Increasing the energy efficiency through cooling the solar cells
- (2) Reducing the costs of the floats the solar cells are on

Solar cells are generally believed to drop 0.5% in energy production efficiency with every 1 degree rise in temperature, with 25°C being standard.

● Solar Power Generation System (30 kW)

<Water Surface>

10 kW × 2 units (on water surface)

Air-cooled: Solar cells are cooled by wind on the water surface

Air-cooled + water-cooled: Solar cells are cooled with sprinklers using the pond water
(Water is sprinkled for one minute every ten minutes)

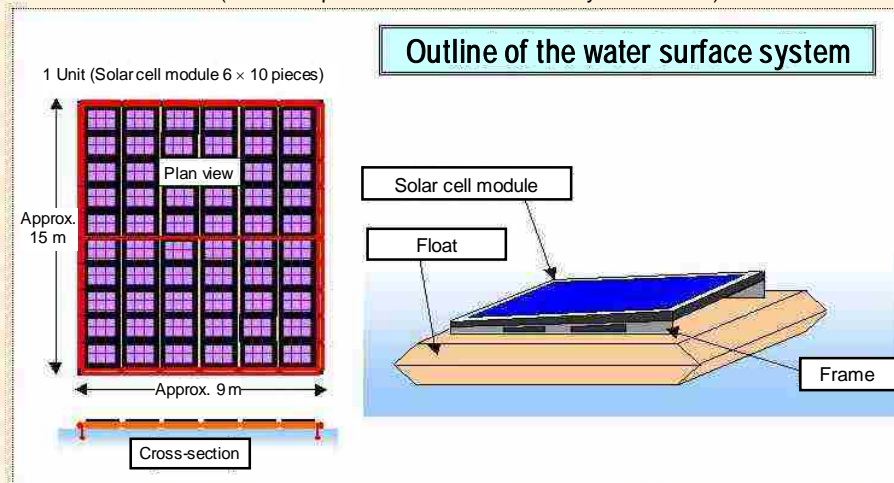

<Land>

10 kW × 1 unit (facing south, angled at 30°, 20 m × 4 m)

● Implementation Period

FY 2007– FY 2008 (scheduled) Start of power generation: August 2007
(The facility is scheduled to be enlarged in FY 2008)



● Effects on Global Warming Prevention

The 30 kW solar power generation system produces the equivalent of enough electricity to run eight typical households for a year (approx. 30,000 kWh).

* The effects of this global warming prevention measure are...

Q : What does this come to when converted into the amount of carbon dioxide prevented?

A: It comes to the equivalent of 21 tons a year
(about ten years of output for a typical person in a household)

Q : What does this come to when converted to forest area?

A: It has the same function as approx. 6 ha of forest area

* This technical development is being carried out jointly between the Japan Water Agency and Kureha Engineering Co. Ltd.

● ● Inquiries ● ●
Japan Water Agency Aichi Irrigation General Management Office
Phone 0561-39-5460



愛知用水

Thank you for your attention